

Precision waveform measurement essentials

Probes and accessories for oscilloscopes

Precision Making

Bulletin Waveform-Acc-01EN

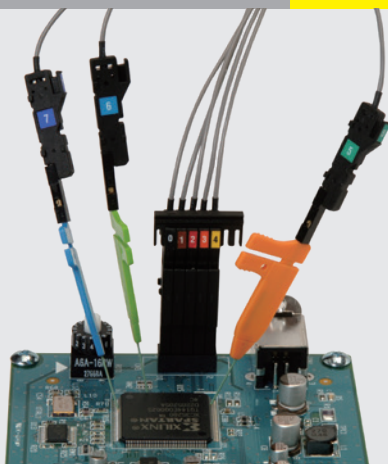

Valid waveform measurement results

An oscilloscope or ScopeCorder is only half the waveform measurement solution. The probe, its interaction with the measuring instrument, and how it is connected to the circuit under test can dramatically affect the quality and validity of the results.

Yokogawa Test&Measurement provides engineering professionals a wide range of accessories that address diverse measurement needs.

■ Probes

To support a broad range of measurement applications, our Precision Makers have developed probes for general purpose use, active probes for high-speed waveform observation, high-voltage differential types for floating power electronics signals, current probes that range from 1 mA to 500 A, and more.

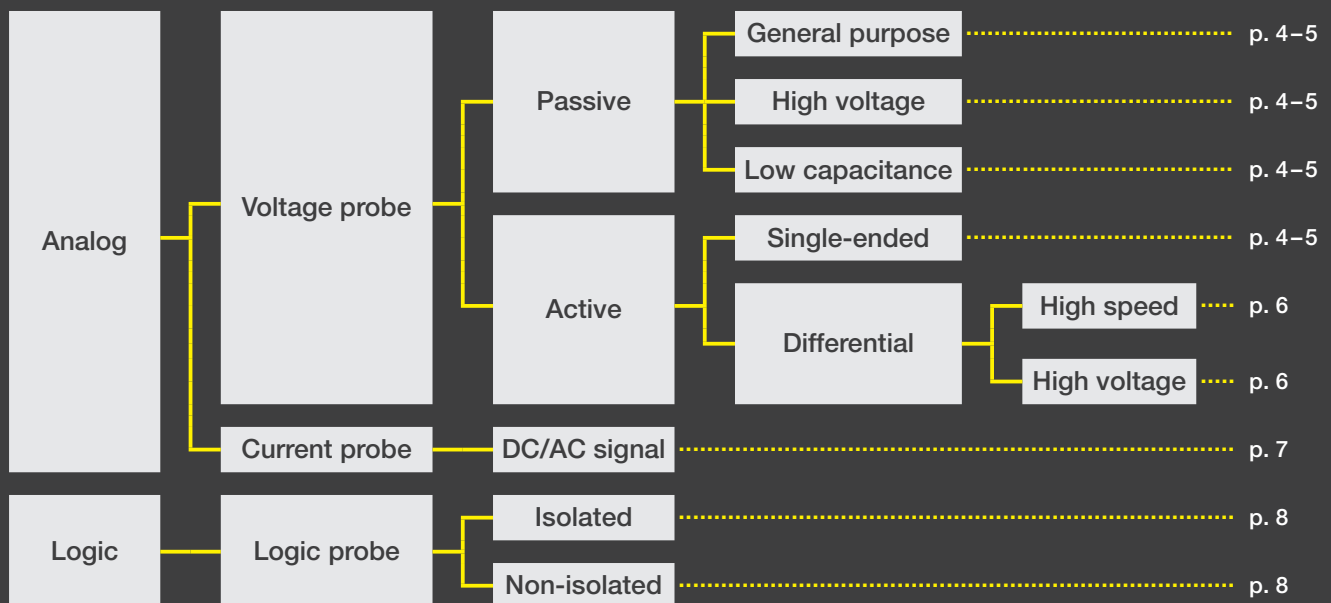

■ Others

- High-voltage Measurement Accessories p. 9
- Cables/Adapters, ScopeCorder accessories, Others p. 10
- Software p. 11

Passive probe chart

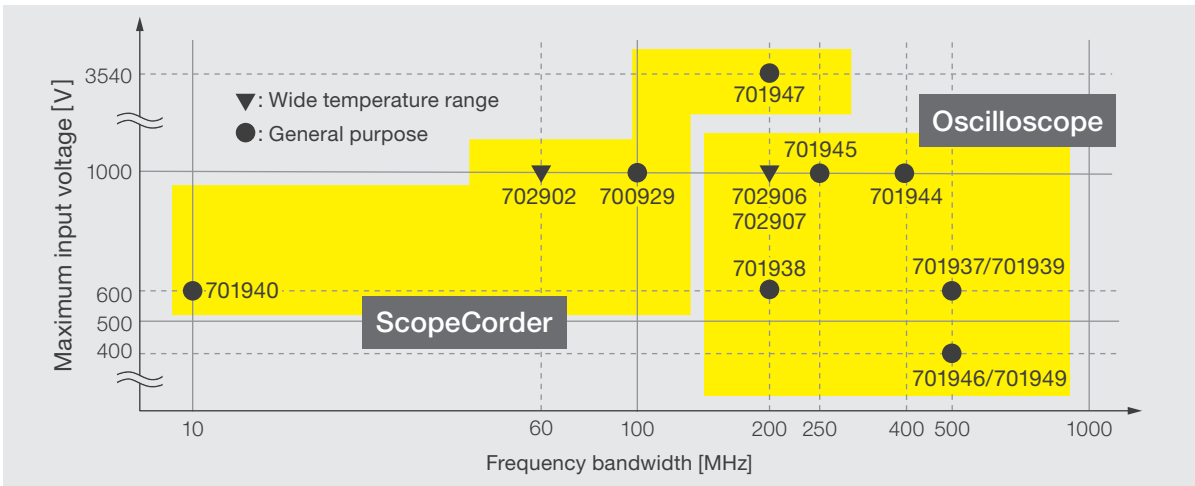

Differential, FET, and low capacitance probe chart

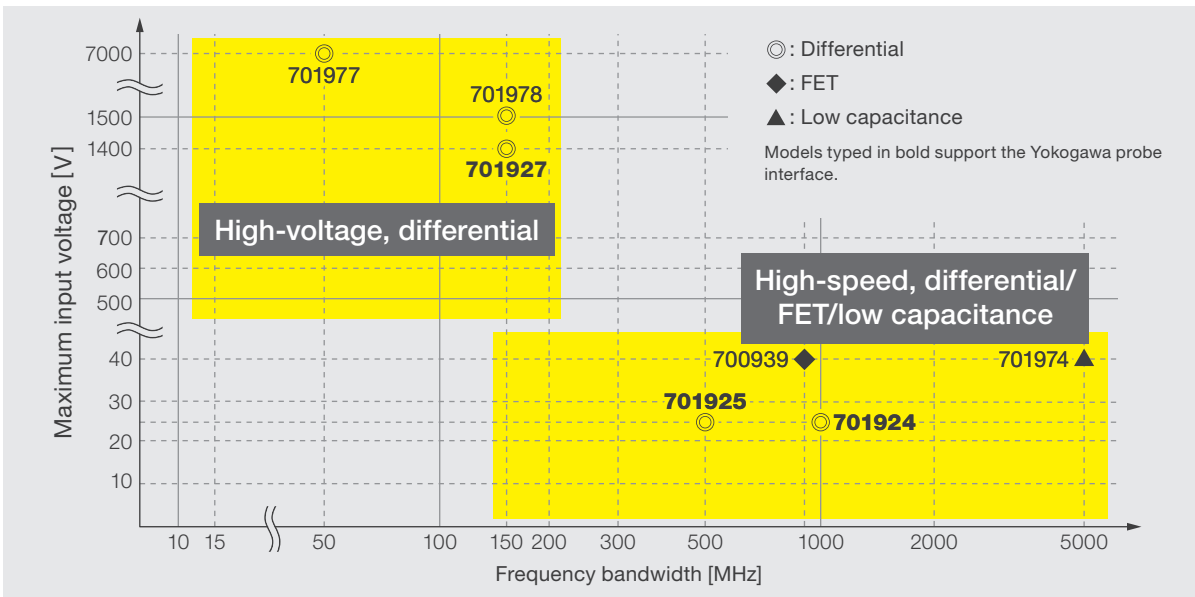

Current probe chart

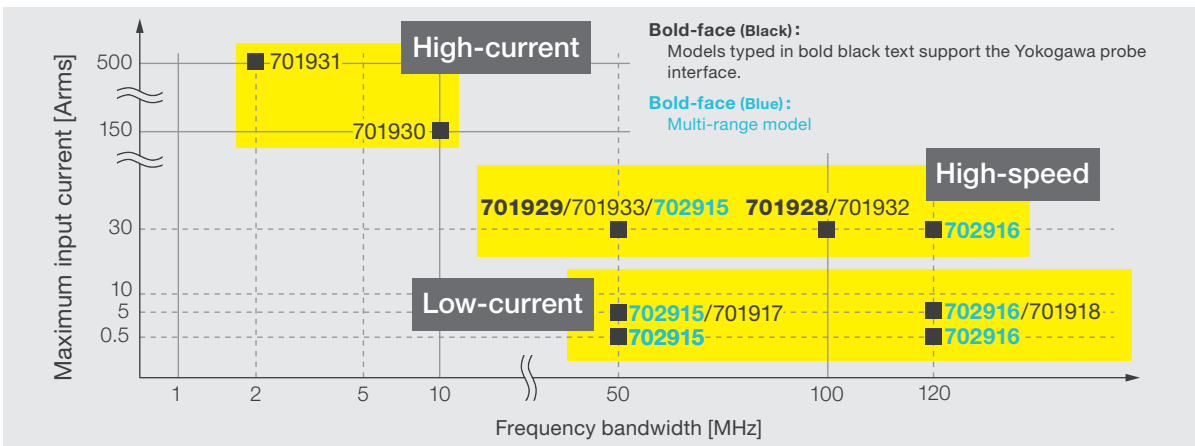











Voltage probes

Passive/FET/Low capacitance

The most basic probe, a passive probe, is also the most versatile. When used with select attachments, passive probes can be used with higher-speed signals. Additionally, Yokogawa Test&Measurement provides probes for extreme cases including high-voltage, wide temperature ranges, and high-speed signal measurement.

For oscilloscope

701937 500 MHz passive probe  <p>10:1 passive probe for DLM3000/5000. Included as a standard accessory.</p>	701949 Miniature passive probe  <p>10:1 miniature passive probe for DLM3000/5000. A wide variety of accessories are included as standard.</p>	702907 10:1 passive probe (Wide operating temperature range)  <p>200 MHz passive probe for DLM3000/5000 with a wider operating temperature range (-40 to 85°C) and total length of 2.5 m.</p>	701938/701939 200 MHz/500 MHz passive probe  <p>10:1 passive probe for DLM2000/4000/6000 and DL6000. Included as a standard accessory.</p>	701946 500 MHz miniature passive probe  <p>10:1 miniature passive probe for DL6000 and DLM2000/4000/6000. Included are the set of accessories useful for probing ICs and high-density PCBs.</p>															
702906 10:1 passive probe (Wide operating temperature range)  <p>10:1 passive probe with a wider operating temperature range (-40 to 85°C) and longer total length than normal passive probes. Suitable for temperature cycling tests.</p>	701943 (PB500) 500 MHz passive probe  <p>10:1 passive probe for DL9000/9500/9700 and SB5000.</p>	701944/701945 100:1 high voltage probe  <table border="1"> <thead> <tr> <th></th> <th>Frequency bandwidth</th> <th>Cable length</th> </tr> </thead> <tbody> <tr> <td>701944</td> <td>400 MHz</td> <td>1.2 m</td> </tr> <tr> <td>701945</td> <td>250 MHz</td> <td>3.0 m</td> </tr> </tbody> </table>		Frequency bandwidth	Cable length	701944	400 MHz	1.2 m	701945	250 MHz	3.0 m	700939 FET probe  <p>The input resistance is higher than other types of active probe. A probe power supply is required.</p>	701974 5 GHz low capacitance probe  <table border="1"> <tbody> <tr> <td>Maximum input voltage</td> <td>20 Vrms 40 VACpeak</td> </tr> <tr> <td>Frequency bandwidth</td> <td>5.0 GHz</td> </tr> <tr> <td>Total length</td> <td>1.1 m</td> </tr> </tbody> </table>	Maximum input voltage	20 Vrms 40 VACpeak	Frequency bandwidth	5.0 GHz	Total length	1.1 m
	Frequency bandwidth	Cable length																	
701944	400 MHz	1.2 m																	
701945	250 MHz	3.0 m																	
Maximum input voltage	20 Vrms 40 VACpeak																		
Frequency bandwidth	5.0 GHz																		
Total length	1.1 m																		

The specified frequency bandwidth of a passive probe is the system bandwidth (-3 dB) when used with the related oscilloscope. The specified bandwidths of FET and active probes are for the probe only. The maximum input voltage is limited by the frequency of the measurement signal.

Passive probe selection guide (Oscilloscopes)

Model (Name)	Frequency bandwidth ¹	Maximum input voltage ²	Attenuation ratio	Input resistance ³ / capacitance ⁴	Total length	Notes
701937	500 MHz	600 V (DC + ACpeak)	10:1	10 MΩ/approx. 10.5 pF	1.3 m	600 V (DC + ACpeak) CAT II, For DLM3000/5000
701938	200 MHz	600 V (DC + ACpeak)	10:1	10 MΩ/approx. 13.5 pF	1.5 m	600 V (DC + ACpeak) CAT II, For DLM2000 (200 MHz models)
701939	500 MHz	600 V (DC + ACpeak)	10:1	10 MΩ/approx. 18.0 pF	1.3 m	600 V (DC + ACpeak) CAT II, For DL6000, DLM2000 (350/500 MHz models), DLM4000/6000
701943 (PB500)	500 MHz	600 V (DC + ACpeak)	10:1	10 MΩ/approx. 12.5 pF	1.5 m	600 V (DC + ACpeak) CAT II, For DL9000/9500/9700, SB5000
701944	400 MHz	1000 Vrms	100:1	50 MΩ/approx. 7.5 pF	1.2 m	1000 Vrms CAT II, 4000 Vpeak
701945	250 MHz	1000 Vrms	100:1	50 MΩ/approx. 7.5 pF	3 m	1000 Vrms CAT II, 4000 Vpeak
701946	500 MHz	400 Vrms	10:1	10 MΩ/approx. 9.5 pF	1.2 m	Miniature passive probe, 1250 Vpeak, 300 Vrms CAT II, For DL6000, DLM2000/4000/6000
701949	500 MHz	400 Vrms	10:1	10 MΩ/approx. 9.5 pF	1.3 m	Miniature passive probe, 1250 Vpeak, 300 Vrms CAT II, For DLM3000/5000
702906	200 MHz	1000 V (DC + ACpeak)	10:1	10 MΩ/approx. 16 pF	2.5 m	1000 V (DC + ACpeak) CAT II, Wide operating temperature (-40 to +85°C), For DLM2000/4000
702907	200 MHz	1000 V (DC + ACpeak)	10:1	10 MΩ/approx. 18.0 pF	2.5 m	1000 V (DC + ACpeak) CAT II, Wide operating temperature (-40 to +85°C), For DLM3000/5000

*1: DC to -3 dB point *2: Depending on the frequency of the measurement signal *3: In combination with corresponding oscilloscopes *4: Defined from the probe tip



FET probes, low capacitance probes selection guide (Oscilloscopes)

Model (Name)	Frequency bandwidth ^{1, 2}	Maximum input voltage ³	Maximum nondestructive voltage ³	Attenuation ratio	Input resistance ² / capacitance ⁴	Total length	Recommended instruments	Power supply
700939	900 MHz	±10 V (DC + ACpeak)	±40 V (DC + ACpeak)	10:1	2.5 MΩ/approx. 1.8 pF	1.5 m	All YOKOGAWA's oscilloscopes	Probe power supply
701974 (PBL5000)	5 GHz	20 Vrms	40 VACpeak	10:1, 20:1	450 Ω/approx. 0.25 pF 950 Ω/approx. 0.4 pF	1.1 m	DL6000/9000 (The instrument of 50 Ω input impedance)	Not required

*1: DC to -3 dB point *2: Defined by a probe only *3: Depending on the frequency of the measurement signal *4: Defined from the probe tip

For ScopeCorder (with isolated BNC inputs)

For safety, metals part of the probe body and the BNC connector are insulated except the probe tip.

<p>702902 10:1 passive probe (Wide operating temperature range)</p>  <p>10:1 passive probe for isolated input modules for the ScopeCorder series having a wider operating temperature range (-40 to 85°C) and total length of 2.5 m. Suitable for temperature cycling tests.</p>	<p>700929 10:1 probe (Safety probe—for use with isolated input modules)</p>  <p>10:1 passive probe for an isolated input module for the ScopeCorder series. The frequency bandwidth is 100 MHz.</p>	<p>701947 100:1 probe (Safety probe—for use with isolated input modules)</p>  <p>100:1 passive probe for an isolated input module for the ScopeCorder series. The frequency bandwidth is 200 MHz.</p>
--	---	---

The frequency bandwidth is DC to -3 dB point. The system bandwidth always depends on the instrument used. The maximum input voltage is limited by the frequency of the measurement signal.

Passive probe selection guide (ScopeCorders: Isolated input module)

Model (Name)	Frequency bandwidth ^{*1}	Maximum input voltage ^{*2}	Attenuation ratio	Input resistance ^{*3} /capacitance ^{*4}	Total length	Notes
702902	60 MHz	1000 V (DC + ACpeak)	10:1	10 MΩ/approx. 17 pF	2.5 m	1000 V (DC + ACpeak) CAT II Wide operating temperature (-40 to +85°C)
700929	100 MHz	1000 V (DC + ACpeak)	10:1	10 MΩ/approx. 18 pF	1.5 m	1000 V (DC + ACpeak) CAT II, 600 Vrms, CAT III
701947	200 MHz	3540 V (DC + ACpeak)	100:1	100 MΩ/approx. 7 pF	1.5 m	3540 V (DC + ACpeak) ^{*5} , 1000 V (DC + ACpeak) CAT II





*1: DC to -3 dB point, the system bandwidth always depends on the instrument used *2: Depending on the frequency of the measurement signal *3: In combination with corresponding input modules *4: Defined from the probe tip. *5: The measurement category is Other (O). Do not use it to measure the main power supply or for Measurement Categories II, III, and IV.

Passive probe selection guide (ScopeCorders: Non-isolated input module)

Model (Name)	Frequency bandwidth ^{*1}	Maximum input voltage ^{*2}	Attenuation ratio	Input resistance ^{*3} /capacitance ^{*4}	Total length	Notes
701940	10 MHz	600V (DC + ACpeak)	1:1, 10:1	10 MΩ/approx. 22 pF (@10:1)	1.5 m	

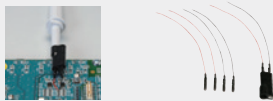
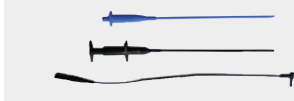
*1: DC to -3 dB point, the system bandwidth always depends on the instrument used *2: Depending on the frequency of the measurement signal *3: In combination with corresponding input modules *4: Defined from the probe tip.

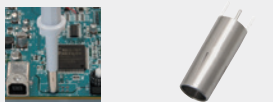
Probe accessories

<p>366946 Solder-in adapter</p>  <p>For 701937, 701938, 701939, 701943 (PB500) and 700939 Standard accessories include: Adapter, red wire (3), black wire (3) *Unsafe for voltage measurements above 42 V.</p>	<p>701948 Plug on clip</p>  <p>Connected to the 700929 and 701947 Maximum input voltage: 1000 V (DC + ACpeak) Length: 0.26 m/0.3 m/0.4 m</p>	<p>700971 Mini clip converter</p>  <p>A clip set designed for 701937, 701938, 701939, 701943 (PB500) and 700939 *Unsafe for voltage measurements above 42 V.</p>	<p>700972 BNC adapter</p>  <p>For 701937, 701938, 701939, 701943 (PB500) and 700939. *Unsafe for voltage measurements above 42 V.</p>
<p>366945 Printed circuit board adapter</p>  <p>For 701937, 701938, 701939, 701943 (PB500) and 700939. Quantity of 1 unit: 10 *Unsafe for voltage measurements above 42 V.</p>	<p>B8099NL 4 mm conversion adapter</p>  <p>Conversion adapters for 702902, 702906 and 702907 probes. Used for connecting to the high voltage measurement terminal adapters. (Pincher tip end)</p>	<p>B8099NM 4 mm conversion adapter</p>  <p>Conversion adapters for 702902, 702906 and 702907 probes. Used for connecting to the high voltage measurement terminal adapters. (Ground lead end)</p>	

Voltage probes

Differential probes

For measuring floating and high-speed differential signals in combination with single-ended input oscilloscopes.

701977

Maximum ± 7000 Vpeak/50 MHz



High voltage differential probe for floating measurements. The attenuation ratio is switchable between 100:1 and 1000:1.

701978

Maximum ± 1500 Vpeak/150 MHz

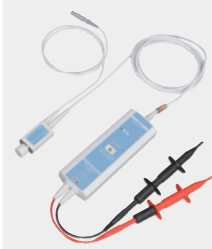

High speed and high voltage differential probe for floating measurements. The attenuation ratio is switchable between 50:1 and 500:1. 100 MHz bandwidth is still maintained when using the 1 m probe tip extension cables.

701927 (PBDH0150)

Maximum ± 1400 Vpeak/150 MHz



High-voltage/high bandwidth differential probe with the YOKOGAWA probe interface. The attenuation ratio is switchable between 50:1 and 500:1 which is recognized by the probe interface that also provides power. 100 MHz bandwidth is still maintained when using the 1 m probe tip extension cables.

701924 (PBDH1000)

Maximum ± 25 Vpeak/1GHz



A 1 GHz high bandwidth differential probe with the YOKOGAWA probe interface which recognizes the probe type and provides power. With 1.1 pF capacitance, it is ideal for measurements on vehicle bus signals such as CAN, CAN FD and FlexRay.

701925 (PBDH0500)

Maximum ± 25 Vpeak/500 MHz



A 500 MHz high bandwidth differential probe with the YOKOGAWA probe interface which recognizes the probe type and provides power. With 1.1 pF capacitance, it is ideal for measurements on vehicle bus signals such as CAN, CAN FD and FlexRay.

Differential probe selection guide^{*3, *4}

Model (Name)	Frequency bandwidth ^{*1, *2}	Attenuation ratio	Maximum allowed differential voltage	Maximum input voltage	Power supply
701924 (PBDH1000)	1 GHz	50:1	± 25 V (DC + ACpeak)	± 35 V (DC + ACpeak)	YOKOGAWA probe I/F
701925 (PBDH0500)	500 MHz	50:1	± 25 V (DC + ACpeak)	± 35 V (DC + ACpeak)	YOKOGAWA probe I/F
701927 (PBDH0150)	150 MHz	500:1 50:1	500:1 ± 1400 V (DC + ACpeak) 50:1 ± 140 V (DC + ACpeak)	± 1400 V (DC + ACpeak) CAT II	YOKOGAWA probe I/F
701977	50 MHz	1000:1 100:1	1000:1 5000 Vrms and 7000 Vpeak 100:1 500 Vrms and 700 Vpeak	5000 Vrms and 7000 Vpeak	Probe power supply
701978	150 MHz	500:1 50:1	500:1 ± 1500 V (DC + ACpeak) 50:1 ± 150 V (DC + ACpeak)	± 1500 V (DC + ACpeak)	Probe power supply







*1: DC to -3 dB point *2: Defined by a probe only

*3: This product has not been designed or manufactured for applications in which high reliability is required over a long time period. This probe is not water or dust resistant. Do not use the probe in areas with a lot of dust or where water may be spilled.

*4: The maximum input voltage depends on the input signal frequency.

Current probes

For measuring high and low currents

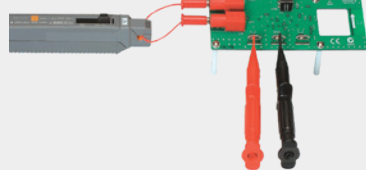
701930 DC to 10 MHz, 150 A 701931 DC to 2 MHz, 500 A	702915 DC to 50 MHz, 30 A/5 A/0.5 A 702916 DC to 120 MHz, 30 A/5 A/0.5 A	701932 DC to 100 MHz, 30 A 701933 DC to 50 MHz, 30 A												
 <p>For measuring the high current of a power device, a motor, or inverter drive without breaking the circuit.</p>	 <p>A current probe with three switchable input ranges: 30 A, 5 A, and 0.5 A. For measuring standby current of home appliances, ECUs, industrial equipment, and inrush current of motors and generators.</p>	 <p>For measuring higher speed current waveforms without breaking the circuit.</p>												
701928 (PBC100) DC to 100 MHz, 30 A 701929 (PBC050) DC to 50 MHz, 30 A	701917 DC to 50 MHz, 5 A 701918 DC to 120 MHz, 5 A	701934 *1 Probe power supply												
 <p>Similar to the 701932/701933 with the YOKOGAWA probe interface. This probe is automatically recognized by a DLM series oscilloscope which also provides power.</p>	 <p>A low noise probe for low current measurement for LED drive circuits, small motors, and more.</p>	 <p>A power supply for current probes, FET probes, and differential probes. Provides power for up to four probes, including large current probes.</p>												
/Px option *1 Probe power option	701936 Deskew correction signal source	<table border="1"> <tbody> <tr> <td>Number of power supply connectors</td> <td>4</td> </tr> <tr> <td>Output voltage</td> <td>±12 V ±0.5 V</td> </tr> <tr> <td>Rated output current</td> <td>+12 V: 2.5 A, -12 V: 2.5 A (the total value of four outputs)</td> </tr> <tr> <td>Rated supply voltage</td> <td>AC100 to 240 V (50/60 Hz)</td> </tr> <tr> <td>External dimensions</td> <td>Approx. 80 (W) × 119 (H) × 200 (D) mm</td> </tr> <tr> <td>Weight</td> <td>Approx. 1.2 kg</td> </tr> </tbody> </table>	Number of power supply connectors	4	Output voltage	±12 V ±0.5 V	Rated output current	+12 V: 2.5 A, -12 V: 2.5 A (the total value of four outputs)	Rated supply voltage	AC100 to 240 V (50/60 Hz)	External dimensions	Approx. 80 (W) × 119 (H) × 200 (D) mm	Weight	Approx. 1.2 kg
Number of power supply connectors	4													
Output voltage	±12 V ±0.5 V													
Rated output current	+12 V: 2.5 A, -12 V: 2.5 A (the total value of four outputs)													
Rated supply voltage	AC100 to 240 V (50/60 Hz)													
External dimensions	Approx. 80 (W) × 119 (H) × 200 (D) mm													
Weight	Approx. 1.2 kg													
 <p>Built-in probe power terminals on the main unit can be used to power current probes, FET probes, and differential probes (/P2, /P4 and /P8 option).</p>	 <p>To enable the skew between voltage and current inputs to be adjusted.</p>													

*1: Probes with the YOKOGAWA probe I/F such as the 701927, 701928 and 701929 do not require a /Px option and 701934 since power is supplied from the front panel.

Current probes selection guide*6

Model (Name)	Frequency bandwidth ¹	Maximum continuous input range ²	Maximum peak current value ²	Amplitude accuracy ³	Total length	Noise ⁴	Power supply ⁵
701917	50 MHz	5 Arms	7.5 Apeak	3%	1.5 m	75 μArms or less	Probe power supply
701918	120 MHz	5 Arms	7.5 Apeak	3%	1.5 m	75 μArms or less	Probe power supply
701928 (PBC100)	100 MHz	30 Arms	50 Apeak	1%	1.5 m	2.5 mArms or less	YOKOGAWA probe I/F
701929 (PBC050)	50 MHz	30 Arms	50 Apeak	1%	1.5 m	2.5 mArms or less	YOKOGAWA probe I/F
701930	10 MHz	150 Arms	300 Apeak	1%	2 m	25 mArms or less	Probe power supply
701931	2 MHz	500 Arms	700 Apeak	1%	2 m	25 mArms or less	Probe power supply
701932	100 MHz	30 Arms	50 Apeak	1%	1.5 m	2.5 mArms or less	Probe power supply
701933	50 MHz	30 Arms	50 Apeak	1%	1.5 m	2.5 mArms or less	Probe power supply
702915	50 MHz	30 Arms	50 Apeak	3%	2.7 m	75 μArms or less	Probe power supply
702916	120 MHz	30 Arms	50 Apeak	3%	2.7 m	75 μArms or less	Probe power supply

*1: DC to -3 dB point, defined by a probe only

*2: Depending on the input signal frequency. See the following website for details: <https://tmi.yokogawa.com/solutions/products/oscilloscopes/current-probes/#Details_Frequency-Derating>

*3: The condition is under the maximum continuous input and DC or 45 to 66 Hz. The amplitude accuracy of a brand-new 701917/701918 is typically 1%.





*4: When used together with a measuring instrument with 20 MHz bandwidth. (30 MHz for the 701917/701918).

*5: The number of probes is limited when using a DL probe power terminal. Please refer to "Relationship between power supply and maximum measurement current" on the web page <<https://tmi.yokogawa.com/solutions/products/oscilloscopes/current-probes/#Details>>.

*6: Output ratios: 701917/701918 = 1 V/A, 701928/701929/701932/701933 = 0.1 V/A, 701930/701931 = 0.01 V/A, 702915/702916 = 0.1 V/A (30 A range), 1 V/A (5 A range), 10 V/A (0.5 A range).

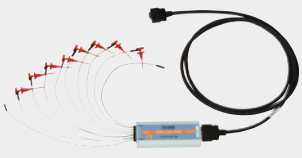
Logic probes and accessories

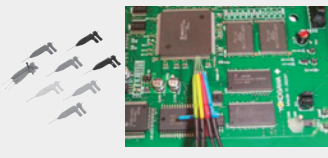
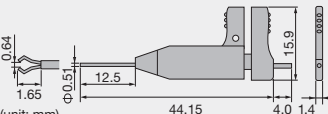
For oscilloscopes



<p>701988 (PBL100) High input impedance logic probe</p>  <p>Maximum toggle frequency: 100 MHz Input impedance (typical value): 1 MΩ/10 pF</p>	<p>701989 (PBL250) High speed logic probe</p>  <p>Maximum toggle frequency: 250 MHz Input impedance (typical value): 100 kΩ/3 pF</p>	<p>B9852ES IC clip</p>  <p>By attaching to the tips of logic probe (701988 or 701989), the IC clips can be used to clip contiguous 0.5 mm pitch terminals. A total of 10 clips are included.</p>  <p>(unit: mm)</p>	<p>701909 Logic probe accessory kit</p>  <p>Logic probe accessory kit for use with 701989.</p>
---	--	---	--

Logic probe selection guide (for oscilloscopes)

Model (Name)	Inputs	Input voltage range	Input impedance	Maximum input voltage	Threshold level	Note
701988 (PBL100)	8	±40 V	1 MΩ/10 pF (Typ.)	±42 V (DC + ACpeak) or 29 Vrms	±40 V at 0.05 V resolution ^{*1}	Maximum toggle frequency is 100 MHz.
701989 (PBL250)	8	±6 V mainly on a setting threshold level	100 kΩ/3 pF (Typ.)	±40 V (DC + ACpeak) or 28 Vrms	±6 V at 0.05 V resolution ^{*1}	Maximum toggle frequency is 250 MHz. Related accessory: 701909

*1: When it is used with DLM2000/3000/4000/5000

For ScopeCorders

<p>700986 High speed logic probe (TTL)</p>  <p>8 bit non-isolated inputs. Two measurement leads (B9879PX and B9879KX) included.</p>	<p>700987 Isolation logic probe</p>  <p>8 bit isolated inputs. Response time: 20 ms (AC) Suitable for high voltage measurement. Use with 758917 leads for 42 V or more. Use with 366961 leads for low level common mode voltages less than 42 V.</p>	<p>702911/702912 High speed logic probe (TTL/Contact input)</p>  <p>8 bit for TTL or contact closure inputs. Two measurement leads (B9879PX and B9879KX) included. Cable length: 1 m (702911), 3 m (702912)</p>
---	--	---











Logic probe selection guide (for ScopeCorders)

Model (Name)	Inputs	Input voltage range	Input impedance	Maximum input voltage	Threshold level	Note
700986	8	±42 V (DC + ACpeak)	Approx. 100 kΩ	±42 V (DC + ACpeak)	1.4 V	TTL input Response time: 1 μs or less
700987	8	DC: H/L detection for 10 V to 250 V (DC) AC: H/L detection for 80 V to 250 V (AC, 50/60 Hz)	Approx. 100 kΩ	250 Vrms CAT II	DC: 6 V ±50% AC: 50 V ±50%	For power supply monitoring and isolated input Response time: DC input: 1 ms or less AC input: 20 ms or less
702911	8	±35 V (DC + ACpeak)	10 kΩ or more	±35 V (DC + ACpeak)	Approx. 1.4 V	Cable length: 1 m TTL, contact input Response time: 3 μs or less
702912	8	±35 V (DC + ACpeak)	10 kΩ or more	±35 V (DC + ACpeak)	Approx. 1.4 V	Cable length: 3 m TTL, contact input Response time: 3 μs or less

High-voltage measurement accessories

These accessories enable safe, high-voltage measurements when used with the DL350, DL950, and SL1000 isolated input modules.

Note: read the User's Manual carefully before making high-voltage measurements

<p>701901 1:1 safety BNC adapter lead</p>  <p>1000 Vrms CAT II, 1.6 m long Safety BNC (plug) to safety banana (plug). Use in combination with a pair of optional adapters or clips. 1000 Vrms CAT II</p>	<p>701904 1:1 safety adapter lead</p>  <p>Plug-in terminal (safety terminal) to safety banana (plug). Cable length: 1.5 m 1000 Vrms CAT II, 600 Vrms CAT III, 1.5 m long</p>	<p>758917 Measurement lead set</p>  <p>A set of 0.8 m long red and black test leads, stackable, used in combination with a pair of optional adapters or clips. 1000 Vrms, 32 Arms CAT II</p>	<p>758933 Measurement lead set</p>  <p>2 pieces (red and black) in 1 set Cable length: 1.0 m Used in combination with a pair of optional adapters or clips. 1000 Vrms, 19 Arms CAT III</p>
<p>701902/701903 Safety BNC cable</p>  <p>1000 Vrms CAT II (BNC-BNC) Cable length: 1 m (701902) 2 m (701903)</p>	<p>701906 Long test clips</p>  <p>Set contains one black and one red clip. 1000 Vrms CAT II</p>	<p>701954 Alligator clip (Dolphin type)</p>  <p>Set contains one black and one red clip. 1000 Vrms CAT II</p>	<p>758928 Pincher tip</p>  <p>Set contains one black and one red clip. 1000 Vrms CAT III</p>
<p>758921 Fork terminal adapter</p>  <p>Set contains one black and one red adapter. 1000 Vrms CAT II</p>	<p>758922 Small alligator-clip adapter</p>  <p>Set contains one black and one red adapter. 300 Vrms CAT II</p>	<p>758929 Large alligator-clip adapter</p>  <p>Set contains one black and one red adapter. 1000 Vrms CAT II</p>	<p>If these clips and adapters are used with differential probes such as the 700924, 701927 etc. the specifications of the maximum input voltage and frequency bandwidth may change. Caution: Take care when using the 758921 as there is a risk of electric shock from exposed metal parts.</p>

Combination examples



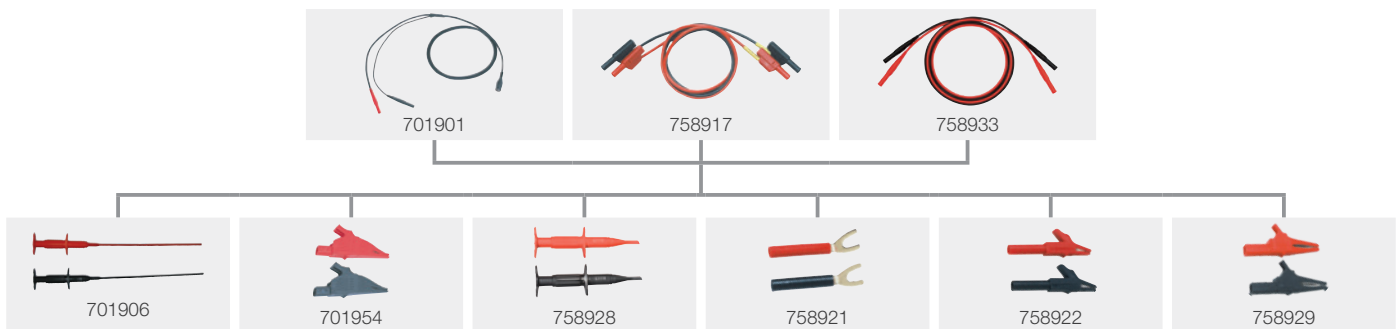

Safe measurements can be performed when using these measurement leads with appropriate clips/adapters.



The lower measurement specification is used when parts are combined.

Cables/Adapters/Other accessories

Cables and adapters

<p>366924*1/366925*1 BNC cable</p>  <p>1 m long (366924) and 2 m long (366925) BNC-BNC cables.</p>	<p>366926*1 BNC cable (1:1)</p>  <p>1 m long BNC-alligator clip cable.</p>	<p>366961*1 Measurement lead</p>  <p>Subassembly of 1.2 m long test leads with alligator-clip adapters.</p>	<p>366973 Go/No-Go cable</p>  <p>For DLM series. Used to connect an external device.</p>
<p>701982 Connection cable</p>  <p>For synchronous operation of DLM5000 (DLMsync) Cable length: 1 m (701982-01) 2.8 m (701982-02)</p>	<p>366921*1 Conversion adapter</p>  <p>BNC (plug)-Banana-jack (female) adapter.</p>	<p>366922*1 Conversion adapter</p>  <p>Banana-plug (male)-BNC (jack) adapter.</p>	<p>366923*1 T-adapter</p>  <p>T-adapter for BNC connectors.</p>
<p>751512*1 Conversion adapter</p>  <p>Safety-terminal-binding-post adapter.</p>	<p>758924 Conversion adapter</p>  <p>An adapter for fitting a 4 mm wide banana jack to a BNC connector (plug).</p>	<p>700976 50 Ω terminator</p>  <p>Used to connect an oscilloscope having a 1 MΩ input to a probe with a 50 Ω output.² Frequency range: DC to 500 MHz. Allowable power: 0.5 W.</p>	<p>*1: Unsafe for voltage measurements above 42 V. *2: Not required for DLM oscilloscopes which can accept 50 Ω terminations directly.</p>

ScopeCorder accessories

<p>701971 DC power cable</p>  <p>For DC power supply model (/DC). Alligator clip type Cable length: 1.8 m</p>	<p>720922 DC power cable</p>  <p>For DL350 Cigarette lighter plug type Cable length: approx. 2.5 m</p>	<p>720901-01/720901-02 Synchronous connecting cable</p>  <p>For SL1000. Capable of synchronous operation for up to 8 units with a total connection cable length of 10 m or less. Cable length: 1 m (720901-01) 3 m (720901-02)</p>
<p>701955/701956 Bridge head</p>  <p>NDIS cable (5 m) included Bridge resistance: 120 Ω (701955) 350 Ω (701956)</p>	<p>701957/701958 Bridge head</p>  <p>D-sub cable (5 m) included Supports Shunt-Cal Bridge resistance: 120 Ω (701957) 350 Ω (701958)</p>	<p>A1002JC NDIS connector</p>  <p>NDIS connector for direct connection to a strain module.</p>

Others

<p>701919 Probe stand</p>  <p>Hands-free circuit board positioner with heavy base and flexible arm. For 8 to 13 mm diameter probes.</p>	<p>438920/21/22 Shunt resistor</p>  <p>Resistance: 250 Ω ±0.1% (438920) 100 Ω ±0.1% (438921) 10 Ω ±0.1% (438922) TCR: ±25 ppm/°C Rated power: 0.3W</p>	<p>701963/64/68/72 Soft carrying case</p> <table border="1"> <thead> <tr> <th>Model</th> <th>Compatible models</th> <th>Size (W) × (H) × (D) mm</th> </tr> </thead> <tbody> <tr> <td>701963</td> <td>DL850</td> <td>450 × 285 × 270</td> </tr> <tr> <td>701964</td> <td>DLM3000</td> <td>335 × 260 × 360</td> </tr> <tr> <td>701968</td> <td>DLM4000/5000</td> <td>520 × 285 × 285</td> </tr> <tr> <td>701972</td> <td>DL950</td> <td>450 × 260 × 275</td> </tr> </tbody> </table> 	Model	Compatible models	Size (W) × (H) × (D) mm	701963	DL850	450 × 285 × 270	701964	DLM3000	335 × 260 × 360	701968	DLM4000/5000	520 × 285 × 285	701972	DL950	450 × 260 × 275
Model	Compatible models	Size (W) × (H) × (D) mm															
701963	DL850	450 × 285 × 270															
701964	DLM3000	335 × 260 × 360															
701968	DLM4000/5000	520 × 285 × 285															
701972	DL950	450 × 260 × 275															

Software

IS8000 Integrated Software Platform

Unify high precision instruments and measurement data to accelerate engineering workflow

- Combines power measurement, high-speed waveform logging, and analysis software in a single platform.
- Seamlessly completes a series of operations from data collection and analysis to report generation.

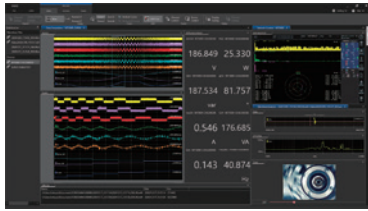

Download the free 30-day trial <<https://tmi.yokogawa.com/p/is8000/>>

Device control	Measurement	Analysis	Export
Device Settings	High-speed Acquisition	Enhanced Viewer	Export to CSV
Remote Monitoring	Power & Waveform Sync.	FFT Analysis	Export to MDF
Connect to Multi units	High-Speed Cam. Sync.	Enhanced Math	Report Generator
IEC Harmonic/Flicker Test & Analysis			IEC 61000

■ Standard functions of the software platform ■ Add-on Functions ■ Only available in IS8011/8012

Other software

Correspondence: Yes Incompatible: No

Category	Software	Features/Description	Off-line waveform display and analysis	Waveform monitoring on a PC	Data transfer to a PC	Command control Custom software development
Free Software	XviewerLITE	Free version of Xviewer. Zoom, V-cursor, conversion to CSV format	Yes	No	No	No
	XWirepuller	Control the DL (M) series from the PC	No	Yes	Yes	No
	Control library "TMCTL"	Create programs and control the instrument remotely	No	No	No	Yes
	DL-Term	Command line tool for the DL series library	No	No	No	Yes
	LabVIEW drivers (for DLM5000/950)	Instrument driver for DL950 and DLM5000 *Program development environment provided by National Instruments (NI)	No	No	No	Yes
Optional Software	MATLAB WDF Access ToolBox	Access to waveform data files saved in WDF format on MATLAB*. *MathWorks's product.	No	No	No	Yes
	Xviewer	Remote control of the instruments using the PC. Trial version available • Waveform observation and analysis • Cursor, Parametric Measure • Statistical Analysis • Multiple file display • Advanced waveform operations • Comment, marking, printing and making report • Optional Math computation feature • Remote monitor • Instruments communication function • Transferring waveform & image files	Yes	Yes	Yes	No

Model numbers and suffix codes

Passive probe

Model	Product	Description
701937	Passive probe	500 MHz bandwidth, ±600 Vpeak
701938	Passive probe	200 MHz bandwidth, ±600 Vpeak
701939	Passive probe	500 MHz bandwidth, ±600 Vpeak
701940	Passive probe	10 MHz bandwidth, ±600 Vpeak
701943	Passive probe	500 MHz bandwidth, ±600 Vpeak
701946	Miniature passive probe	500 MHz bandwidth, 400 Vrms
701949	Miniature passive probe	500 MHz bandwidth, 400 Vrms
701944	100:1 high voltage probe	400 MHz bandwidth, 1000 Vrms, cable length: 1.2 m
701945	100:1 high voltage probe	250 MHz bandwidth, 1000 Vrms, cable length: 3.0 m
702906	10:1 passive probe (Wide operating temperature)	200 MHz bandwidth, ±1000 Vpeak
702907	10:1 passive probe (Wide operating temperature)	200 MHz bandwidth, ±1000 Vpeak
700929	10:1 probe	100 MHz bandwidth, ±1000 Vpeak, for use with isolated BNC inputs
701947	100:1 probe	200 MHz bandwidth, ±1000 Vpeak, for use with isolated BNC inputs
702902	10:1 passive probe (Wide operating temperature)	60 MHz bandwidth, ±1000 Vpeak, for use with isolated BNC inputs
701974	Low capacitance probe	5 GHz bandwidth, 500 Ω or 1 kΩ input impedance

FET probe/Probe accessories

Model	Product	Description
700939	FET probe	900 MHz bandwidth, ±10 Vpeak
366945	PCB adapter	For 701937, 701938, 701939, 701943, 700939 (10 pieces)
366946	Solder-in adapter	For 701937, 701938, 701939, 701943, 700939
700971	Mini clip converter	For 701937, 701938, 701939, 701943, 700939
700972	BNC adapter	For 701937, 701938, 701939, 701943, 700939
701948	Plug on clip	For 700929, 701947

Differential probe

Model	Product	Description
701977	Differential probe	Maximum ±7000 Vpeak, 50 MHz bandwidth
701978	Differential probe	Maximum ±1500 Vpeak, 150 MHz bandwidth
701924	Differential probe	Maximum ±25 Vpeak, 1 GHz bandwidth, probe I/F
701925	Differential probe	Maximum ±25 Vpeak, 500 MHz bandwidth, probe I/F
701927	Differential probe	Maximum ±1400 Vpeak, 150 MHz bandwidth, probe I/F

Current probe

Model	Product	Description
701917	Current probe	DC to 50 MHz, 5 Arms, high-sensitivity
701918	Current probe	DC to 120 MHz, 5 Arms, high-sensitivity
701928	Current probe	DC to 100 MHz, 30 Arms, probe I/F
701929	Current probe	DC to 50 MHz, 30 Arms, probe I/F
701930	Current probe	DC to 10 MHz, 150 Arms
701931	Current probe	DC to 2 MHz, 500 Arms
701932	Current probe	DC to 100 MHz, 30 Arms
701933	Current probe	DC to 50 MHz, 30 Arms
701934	Power supply	Number of connectors: 4
701936	Deskew correction signal source	For voltage to current skew adjustment
702915	Current probe	DC to 50 MHz, 30 Arms, 3 input ranges
702916	Current probe	DC to 120 MHz, 30 Arms, 3 input ranges

Logic probe

Model	Product	Description
700986	Logic probe	TTL input
700987	Logic probe	Isolated input
701988	Logic probe	Maximum toggle frequency: 100 MHz
701989	Logic probe	Maximum toggle frequency: 250 MHz
702911	Logic probe	TTL/contact input, cable length: 1 m
702912	Logic probe	TTL/contact input, cable length: 3 m
B9852ES	IC clip	For contiguous 0.5 mm pitch terminals
701909	Accessory kit	For 701989

High voltage measurement accessories

Model	Product	Description
701901	1:1 safety BNC adapter lead	1000 Vrms CAT II, Cable length:1.6 m
701904	1:1 safety adapter lead	1000 Vrms CAT II, Cable length:1.6 m
(701901/701904 can use with the accessories below.)		
701906	Long test clips	1000 Vrms CAT II, A set of black and red clip
701954	Alligator clip (Dolphin type)	1000 Vrms CAT II, A set of black and red clip
758921	Fork terminal adapter	1000 Vrms CAT II, A set of black and red clip
758922	Small alligator-clip adapter	300 Vrms CAT II, A set of black and red clip
758929	Large alligator-clip adapter	1000 Vrms CAT II, A set of black and red clip
701902	Safety BNC cable	1000 Vrms, Cable length: 1 m
701903	Safety BNC cable	1000 Vrms, Cable length: 2 m
758917	Measurement lead set	1000 Vrms CAT II, A set of black and red cable
758933	Measurement lead set	1000 Vrms CAT III, A set of black and red cable

Cables

Model	Product	Description
366924	BNC cable	Total length: 1 m
366925	BNC cable	Total length: 2 m
366926	BNC cable	BNC-alligator clip cable, Total length: 1 m
366961	Measurement lead	Banana-plugs (male) cable with alligator clips
366973	GO/NO-GO Cable	For DLM series

Adapters

Model	Product	Description
366921	Conversion adapter	BNC-banana-jack (female) adapter
366922	Conversion adapter	Banana-plug (male)-BNC adapter
366923	T-adapter	T-adapter for BNC connectors
751512	Conversion adapter	Safety terminal-binding post adapter
758924	Conversion adapter	BNC-banana jack (female) adapter
700976	50 Ω terminator	Feed-through type
701982-01	Connection cable	For DLM5000 (DLMsync), Cable length: 1 m
701982-02	Connection cable	For DLM5000 (DLMsync), Cable length: 2.8 m

ScopeCorder accessories

Model	Product	Description
701955	Bridge head	NDIS cable (5 m) included, 120 Ω
701956	Bridge head	NDIS cable (5 m) included, 350 Ω
701957	Bridge head	D-sub cable (5 m) included, 120 Ω
701958	Bridge head	D-sub cable (5 m) included, 350 Ω
A1002JC	NDIS connector	For strain module
701971	DC power cable	Alligator clip type
720901-01	Synchronous connecting cable	For SL1000, Cable length: 1 m
720901-02	Synchronous connecting cable	For SL1000, Cable length: 3 m
720922	DC power cable	For DL350, cigarette lighter plug type

Printer Paper

Model	Product	Description	Sales unit
B9988AE	Printer paper	For DL750/850/6000/9000, DLM2000/3000/4000/5000	10

Please order multiple of the order quantity.

Model	Product	Description
701966	Printer paper	For DL750P, SL1400 (6 rolls)

YOKOGAWA

YOKOGAWA TEST & MEASUREMENT CORPORATION
Global Sales Dept. /E-mail: tm@cs.jp.yokogawa.com

YOKOGAWA CORPORATION OF AMERICA
YOKOGAWA EUROPE B.V.
YOKOGAWA TEST & MEASUREMENT (SHANGHAI) CO., LTD.
YOKOGAWA ELECTRIC KOREA CO., LTD.
YOKOGAWA ENGINEERING ASIA PTE. LTD.
YOKOGAWA INDIA LTD.
YOKOGAWA ELECTRIC CIS LTD.
YOKOGAWA AMERICA DO SUL LTDA.
YOKOGAWA MIDDLE EAST & AFRICA B.S.C(c)

<https://tmi.yokogawa.com/us/>
<https://tmi.yokogawa.com/eu/>
<https://tmi.yokogawa.com/cn/>
<https://tmi.yokogawa.com/kr/>
<https://tmi.yokogawa.com/sg/>
<https://tmi.yokogawa.com/in/>
<https://tmi.yokogawa.com/ru/>
<https://tmi.yokogawa.com/br/>
<https://tmi.yokogawa.com/bh/>

Others

Model	Product	Description
438920	Shunt resistor	250 Ω±0.1%, 0.3 W, ±25 ppm/°C
438921	Shunt resistor	100 Ω±0.1%, 0.3 W, ±25 ppm/°C
438922	Shunt resistor	10 Ω±0.1%, 0.3 W, ±25 ppm/°C
701919	Probe stand	Attachable probe: approx. dia. 8 to 13 mm

Carrying Cases

Model	Product	Description
701963	Soft carrying case	For DL850
701964	Soft carrying case	For DLM3000
701968	Soft carrying case	For DLM4000/5000
701972	Soft carrying case	For DL950
93050	Carrying case	For DL350

Rack mount kit

Model	Product	Description
701969-E	Rack mount kit	For DLM4000/5000 (EIA)
751541-E4	Rack mount kit	For SL1000 (EIA)

Front Panel Protective Covers

Model	Product	Description
B8219EP	Front cover	For DLM3000
B8059EP	Front cover	For DLM2000
B8069CH	Front cover	For DLM4000
B8074EA	Front cover	For DL850
B8217CB	Front panel protective cover	For DL950
B8229CH	Front panel protective cover	For DLM5000

Software

Product	Model	Suffix code	Description
IS8000 Integrated Software Platform	IS8001**		IS8000 Integrated Software Platform Subscription (Annual license)
			IS8000 Integrated Software Platform Perpetual (Permanent license)
Xviewer	701992		Advanced waveform display and analysis
		-SP01	Standard Edition (1 license)
		-GP01	Math Edition (1 license)
		/JS01	DL850 Advanced Utility (1 license)
XviewerLITE	(Free software)		Basic waveform display and measurement
XWirepuller	(Free software)		Waveform monitoring and instrument control

*1: See Bulletin IS8000-01EN for more detail about IS8000.

Visit the following web sites for details about this software:
<<http://tmi.yokogawa.com/products/oscilloscopes/oscilloscopes-application-software/>>

Any company's names and product names mentioned in this document are trade names, trademarks or registered trademarks of their respective companies.

NOTICE

- Before operating the product, read the user's manual thoroughly for proper and safe operation.

<https://tmi.yokogawa.com/>

YMI-N-MI-M-E03

The contents are as of January 2022. Subject to change without notice.
Copyright © 2022, Yokogawa Test & Measurement Corporation
[Ed: 01/b] Printed in Japan, 201(KP)